

ACCESSORIES

Fisher® Padded Carry Bag

Rugged double stitched construction. Includes handy exterior pocket for extra batteries or small accessories.
– 103693000C

Fisher® Camo Pouch

Camo pouch with two inside pockets, belt included. – PCH-F

Stereo Headphones

Use with Fisher® metal detectors. Lightweight and adjustable with true stereo sound, adjustable volume, 1/4 jack with 1/8 adaptor, 4' cable. – 9720950000

Metal Sand Scoop

Large galvanized metal scoop with filtering holes. Strong Rubberized grip. – SAND SCOOP

Lesche Knife

Made from high quality heat-treated tempered steel. The ultimate digging tool. Comes with a durable sheath. 12" in length with a 7" serrated blade. – LESCHE KNIFE

Fisher® Baseball Cap

One size fits all. – FCAP

Fisher® T-Shirt

100% cotton with Fisher® Logo. Sizes: S, M, LG, XL & XXL – FTSHIRT

Replacement/Accessory Search Coils

11" Biaxial Standard Coil (replacement) – 11COIL-F4F
4" Concentric Accessory Coil – 4COILF
8" Concentric Accessory Coil – 8COIL-7BLKF
10" Concentric Accessory Coil – 10COILF

Coil Covers

Specially made to protect your coil from abrasion and damage.
11" Biaxial Standard Coil Cover – COVER-11DD
4" Concentric Accessory Coil Cover – 4COVER
8" Concentric Accessory Coil Cover – 8COVER-7
10" Concentric Accessory Coil Cover – 10COVER

Rain Cover

Neoprene rain cover specially made to protect your F2 from weather – RAINCOV-F2

Gold Prospecting Kits

Items Included:

	Gold Kit PART NUMBER: GOLDKIT1	Deluxe Kit PART NUMBER: GOLDKIT2	Hardrock Kit PART NUMBER: GOLDKIT3
10 1/2" Gold Pan	x	x	x
14" Gold Pan	x	x	x
Classifier		x	x
2 – Shatterproof Vials	x	x	x
Snuffer Bottle	x	x	x
Black Sand Magnet		x	x
Treasure Scoop		x	x
Tweezers			x
Magnifier			x
Crevice Tool			x
Rock Pick			x
Instruction Booklet	x	x	x
Backpack		x	x

FOR COMPLETE DETAILS VISIT WWW.FISHERLAB.COM • 1-800-685-5050

F4

HOBBY METAL DETECTOR

OPERATING MANUAL

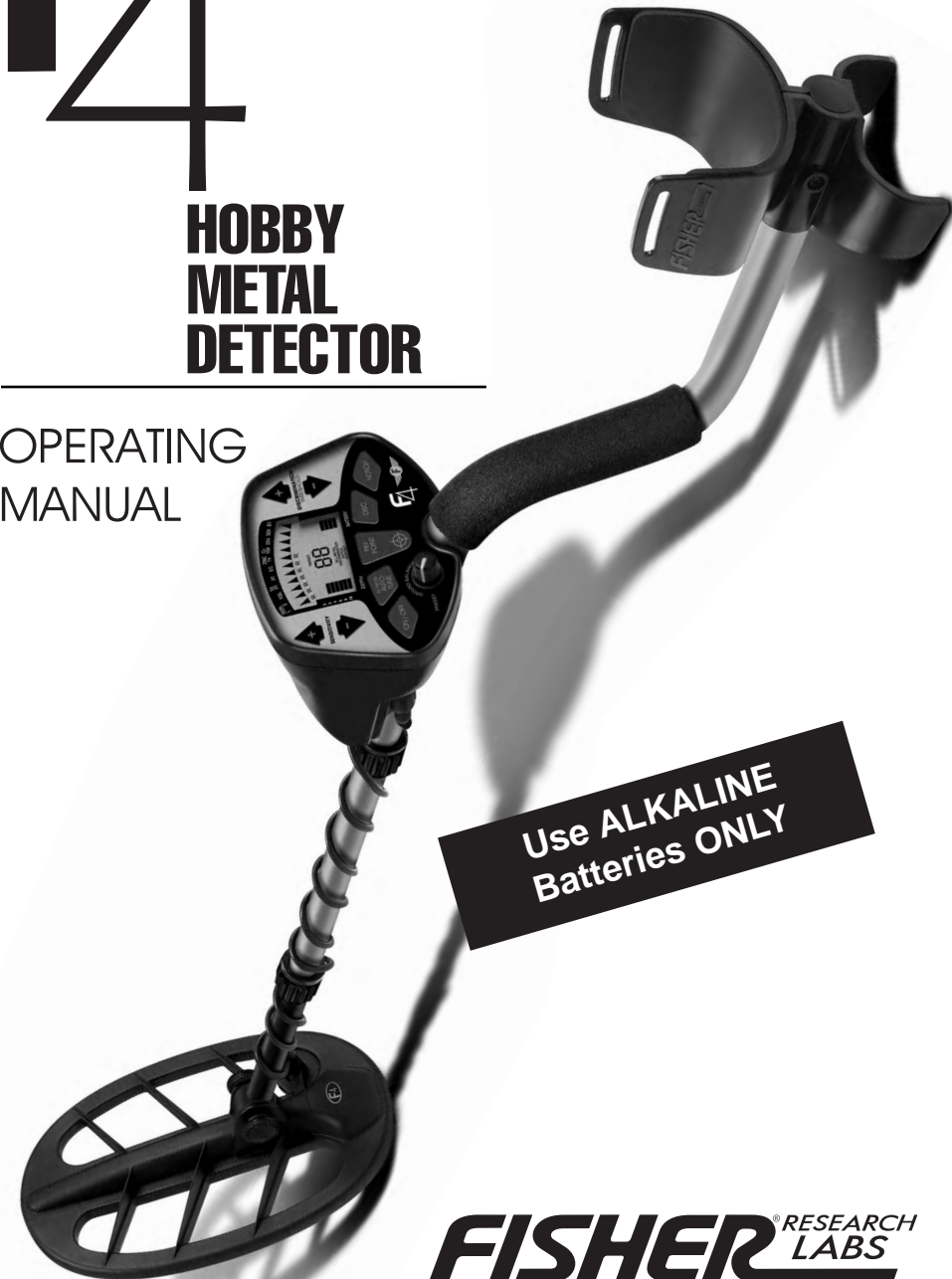

FISHER RESEARCH
LABS

TABLE OF CONTENTS

Terminology	3
Assembly	4
Batteries	5
Headphones	5
Quick-Start Demo	6-7
Control Panel	8-11
Sensitivity	8
Auto Tune	8
Discrimination Control	9
Pinpoint	10
Disc	10
Notch	11
Ground Balancing	12-13
Quick Ground Balancing	13
4-Tone Audio System	14
Depth and Target Display	15-16
Target Readout Table	16
DD Coil Characteristics	17
Bottle Cap Discrimination	17
Sweet Spot	17
Sensitivity Adjustment	18
Electromagnetic Interference	18
Severe Ground Conditions	18
Search Techniques	19
Target Verification	19
Pinpointing with motion modes	19
Target Pinpointing (No motion)	20
Treasure Hunter's Code of Ethics	21
Warranty	21
Accessories	Back Page

NOTES

TERMINOLOGY

The following terms are used throughout the manual, and are standard terminology among treasure hunters.

ELIMINATION

Reference to a metal being "eliminated" means that the detector will not emit a tone, nor light up an indicator, when a specified object passes through the searchcoil's detection field.

DISCRIMINATION

When the detector emits different tones for different types of metals, and when the detector "eliminates" certain metals, we refer to this as the detector "discriminating" among different types of metals.

Discrimination is an essential feature of professional metal detectors. Discrimination allows the user to ignore trash and other undesirable objects.

RELIC

A relic is an object of interest by reason of its age or its association with the past. Many relics are made of iron, but can also be made of bronze or precious metals.

IRON

Iron is a common, low-grade metal that is an undesirable target in certain metal detecting applications. Examples of undesirable iron objects are old cans, pipes, bolts and nails.

Sometimes, the desired target is made of iron. Property markers, for instance, contain iron. Valuable relics can also be composed of iron; cannon balls, old armaments, and parts of old structures and vehicles can also be composed of iron.

FERROUS

Metals which are made of, or contain, iron.

PINPOINTING

Pinpointing is the process of finding the exact location of a buried object. Long-buried metals can appear to the eye exactly like the surrounding soil, and can therefore be very hard to isolate from the soil.

PULL-TABS

Discarded pull-tabs from beverage containers are an especially bothersome trash item for treasure hunters. They come in many different shapes and sizes. Pull-tabs can be eliminated from detection, but some other valuable objects can have a magnetic signature similar to pull-tabs, and will also be eliminated when discriminating out pull-tabs.

GROUND BALANCE

Ground Balancing is the ability of the detector to ignore, or "see through" the earth's naturally occurring minerals, and only sound a tone when a metal object is detected. The Gold Bug incorporates proprietary circuitry and programming to eliminate false signals from severe ground conditions.

ASSEMBLY

Caution: Forcing in MIDDLE STEM with CAM LOCK raised may form a burr on camlock. If this happens, remove burr with knife to allow insertion.

- 1 Position detector upright.
- 2 Rotate the LOCKING COLLAR fully in the counterclockwise direction.
- 3 Insert your finger inside the tube and make sure the INTERNAL CAM LOCK is flush with the inside of the tube.

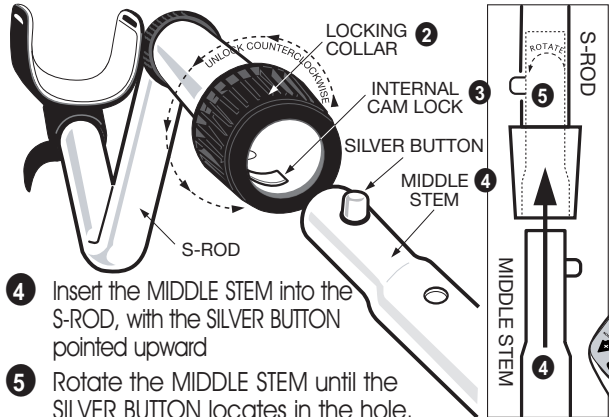

- 4 Insert the MIDDLE STEM into the S-ROD, with the SILVER BUTTON pointed upward
- 5 Rotate the MIDDLE STEM until the SILVER BUTTON locates in the hole.
- 6 Twist the LOCKING COLLAR fully in the clockwise direction until it locks.
- 7 Repeat this process on the LOWER STEM.
- 8 Using the BOLT and KNURLED KNOB, attach the SEARCHCOIL to the LOWER STEM.
- 9 Adjust the LOWER STEM to a length that lets you maintain a comfortable upright posture, with your arm relaxed at your side, and the SEARCHCOIL parallel to the ground in front of you.

- 10 Wind the CABLE securely around the STEMS.
- 11 Connect CABLE PLUG to housing. Do not twist the Cable or Plug. Turn Locking Ring only. Use minimal finger pressure to start the threads. Do not cross-thread. When the Locking Ring is fully engaged over the threaded connector, give it a firm turn to make sure that it is very tight. When the Locking Ring is fully engaged over the threaded connector, it may not cover all of the threads.

- 12 Tighten both LOCKING COLLARS.

Armrest Adjustment

If you wish to change the position of the armrest, remove the screw and move the armrest to one of the alternate hole locations.

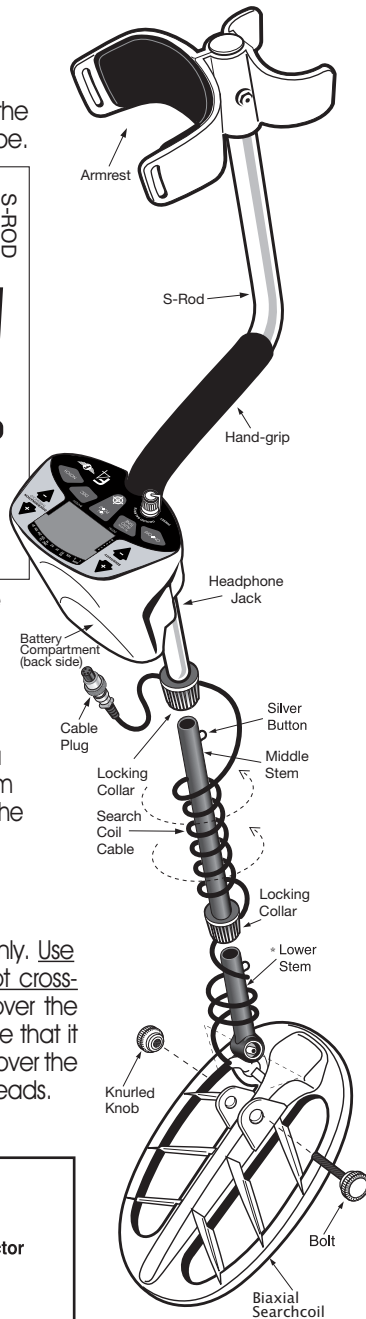
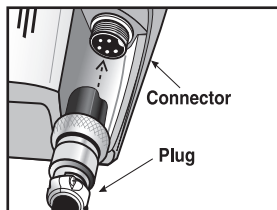

TREASURE HUNTER'S CODE OF ETHICS:

- Always check Federal, State, County and local laws before searching.
- Respect private property and do not enter private property without the owner's permission.
- Take care to refill all holes and leave no damage.
- Remove and dispose of any and all trash and litter found.
- Appreciate and protect our inheritance of natural resources, wildlife and private property.
- Act as an ambassador for the hobby, use thoughtfulness, consideration and courtesy at all times.
- Never destroy historical or archaeological treasures.
- All treasure hunters may be judged by the example you set; always conduct yourself with courtesy and consideration of others

According to FCC part 15.21 Changes or Modifications made to this device not expressly approved by the party responsible for compliance could void the users authority to operate this equipment. This device complies with FCC Part 15 Subpart B Section 15.109 Class B.

5-YEAR LIMITED WARRANTY

The F4 metal detector is warranted against defects in materials and workmanship under normal use for five years from the date of purchase to the original owner.

Damage due to neglect, accidental damage or misuse of this product is not covered under this warranty. Decisions regarding abuse or misuse of the detector are made solely at the discretion of the manufacturer.

Proof of Purchase is required to make a claim under this warranty.

Liability under this Warranty is limited to replacing or repairing, at our option, the metal detector returned, shipping cost prepaid to Fisher Labs. Shipping cost to Fisher Labs is the responsibility of the consumer.

To return your detector for service, please first contact Fisher Labs for a Return Authorization (RA) Number. Reference the RA number on your package and return the detector within 15 days of calling to:

FISHER RESEARCH LABS

1465-H Henry Brennan Dr.
El Paso, TX 79936
Phone: 915-225-0333 ext.118

Warranty coverage does not include the cost of transporting the detector back to an owner who is located outside of the United States of America.

NOTE TO CUSTOMERS OUTSIDE THE U.S.A.

This warranty may vary in other countries, check with your distributor for details. Warranty does not cover shipping costs.

Copyright© 2013
All rights reserved, including the right to reproduce this book, or parts thereof, in any form.
Fisher® is a registered trademark of Fisher Research Labs

www.fisherlab.com

MADE IN USA

*Note: Very tall users can purchase the optional Extended Lower Stem (TUBE5X), for extended reach.

TARGET PINPOINTING *(no-motion PINPOINT mode)*

After you have identified a target using a motion mode of detection, press the PINPOINT pad to identify the target's exact location. This technique can yield more information about the target's shape and size and also find its exact location to facilitate excavation.

Pinpoint (in no-motion mode) as follows:

1. Position the searchcoil just barely off the ground, and to the side of the target.
2. Press PINPOINT pad and raise the searchcoil about 2 inches. Lifting the searchcoil away from the ground makes the ground signal go negative, so the machine is silent.
3. Now move the searchcoil slowly across the target, and you can locate it by the sound. The target is located directly under where the sound is loudest.

Narrow It Down:

1. To narrow the response further, position the center of the searchcoil near the center of the response pattern, but not directly over the center.
2. Press PINPOINT pad again.
3. Repeat this narrowing procedure to narrow the field of detection further.

Note: Depth indication is less accurate after narrowing.

COIL DRIFT

If you plan to use the PINPOINT mode for continuous searching, realize that drift will occur over time, causing the detector to gain or lose sensitivity.

Periodic retuning of the detector is required to minimize drift; press PINPOINT to retune.

Temperature change will cause the coil to drift in point mode.

If the detector moves from a cooler to a warmer environment, the detector may emit a constant tone until the temperature stabilizes; if so, retune.

If the detector moves from a warmer to a cooler environment, the detector may lose sensitivity (remaining quiet); if so, retune.



BATTERIES

Two 9-Volt batteries are supplied with the F2.

The batteries have been inserted backwards in the compartment for storage during transportation. Please remove batteries, turn them around, and install correctly.

Use **ALKALINE** batteries only.

DO NOT MIX OLD AND NEW BATTERIES.

To install the batteries:

- 1 Remove the battery cover by disengaging the clip at the back.
Do not hinge door upward; pull straight back
- 2 Align the polarity of the batteries correctly, with the positive "+" toward the coil plug connection, as indicated by the + indicator on the housing.
- 3 Insert (2) 9-Volt **ALKALINE** batteries, with the contacts pointed inward, and press down on the back of the batteries to snap them into place.
Some brands of batteries will require moderate force to clear the retaining tabs.
- 4 Replace the battery door.

Most metal detector problems are due to improperly installed batteries, or the use of non-alkaline or discharged batteries. **If the detector does not turn on, please check the batteries.**

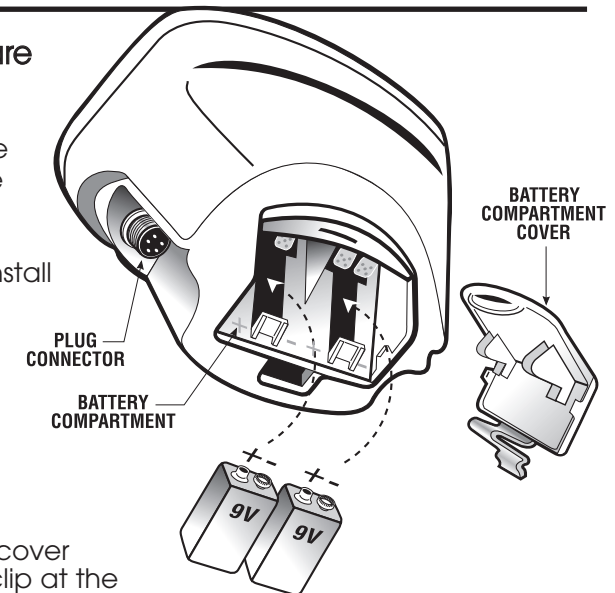

USING HEADPHONES

Using headphones (not included) improves battery life, and prevents the sounds from annoying bystanders.

It also allows you to hear subtle changes in the sound more clearly, particularly if searching in a noisy location. For safety reasons, do not use headphones near traffic or where other dangers are present. This device is to be used with interconnecting cables/headphone cables shorter than three meters.

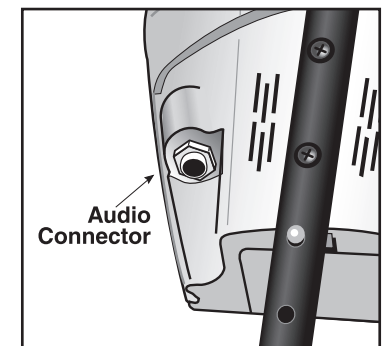

QUICK-START DEMONSTRATION

I. Supplies Needed

- A Nail
- A Pull-Tab from a beverage can
- A Nickel
- A Quarter
- A Zinc Penny (dated after 1982)

II. Position the Detector

- Place the detector on a table, with the search coil hanging over the edge. (or better, have a friend hold the detector, with the coil off the ground).
- Keep the searchcoil away from walls, floors, and metal objects.
- Remove watches, rings and other jewelry or metal objects from hands and wrists.
- Turn off appliances or lights that cause electromagnetic interference.
- Pivot the search coil back toward the detector body.



III. Power Up

Press the ON/OFF touch pad.

IV. Wave each Object over the Search Coil

- Notice a different tone for each object.

Low Tone: Nail
Low Mid Tone: Pull-Tab
Medium Tone: Zinc Penny
High Tone: Quarter

- Motion is required. Objects must be in motion over the search coil to be detected.

V. Press the DISC touch pad

The detector will beep and 2 "R"'s will appear under the iron indicators.

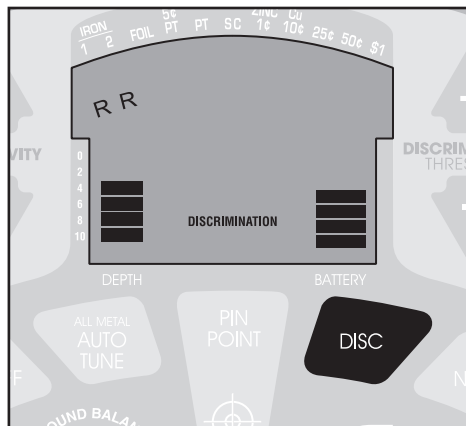
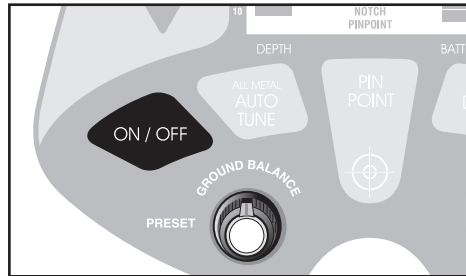

SEARCH TECHNIQUES (in DISC mode)

Target Verification

After detecting a target, do the following:

- Walk around the target in a circle.
- While circling the target, continue sweeping the searchcoil across the target.
- Sweep once every 30° or 40° of the circle.

If the tone does not change and the target ID value is consistent as you circle the target, you can be highly confident of the target's identification.

If the tone or target ID changes as you circle the target, you may have multiple targets or an irregularly shaped object.

If the tone completely disappears at different angles, the target may be trash or a low-value metal.

If you are new to the hobby, dig all targets. With practice in the field, you will soon identify audible and visual target feedback with certain types of metal objects.

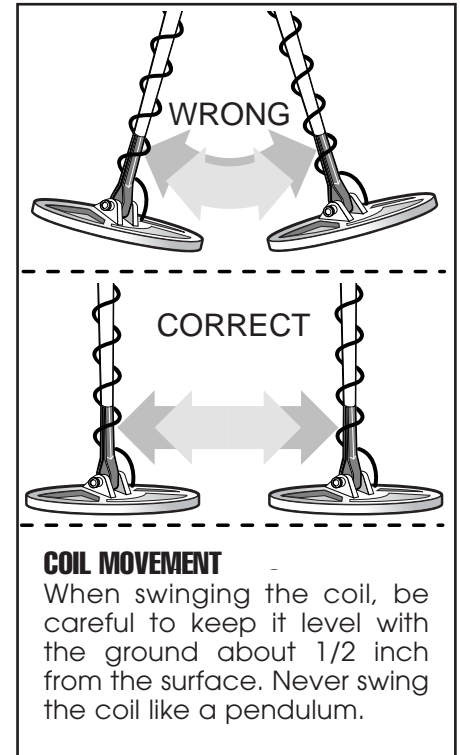

Pinpointing process in motion modes:

- Sweep over target in narrowing side-to-side pattern
- Take visual note of spot on ground where "beep" occurs.
- Step 90° to the side of the target
- Sweep coil over same area, at 90° to 1st sweep pattern.
- This pinpoints the target location with an "X"

SENSITIVITY ADJUSTMENT

ELECTROMAGNETIC INTERFERENCE

Use the Sensitivity Control is to eliminate Electromagnetic Interference (EMI). The F4 metal detector is an extremely sensitive device; the search coil creates its own magnetic field and acts like an antenna. If your detector beeps erratically when the search coil is motionless, the unit is probably detecting another electromagnetic field.

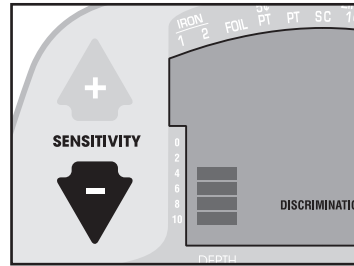

Common sources of EMI are electric power lines, both suspended and buried, motors, and household appliances like computers and microwave ovens. Some indoor electronic devices, such as dimmer switches used on household lighting, produce severe EMI and can cause the detector to beep erratically. Other metal detectors also produce their own electromagnetic fields; so if detecting with a friend, keep two metal detectors at least 20 feet apart.

If the detector beeps erratically, **REDUCE THE SENSITIVITY** by pressing the **Sensitivity -** Pad on the left of the control panel.

In most urban environments, you should be able to search without chatter from interference at the default sensitivity setting (default setting is the sensitivity level at power-up, 4 bars), or at one level reduced from default. At maximum sensitivity, the F4 will "chatter" in proximity to underground or overhead power lines, or to indoor or outdoor electrical devices. In fact, if you notice rapid chatter with the searchcoil near the ground, you may be able to trace the approximate location of the underground power lines by following the chatter.

To manage chatter, which is most likely from electrical interference:

1. **REDUCE the SENSITIVITY** until the chatter stops.
2. Try sweeping it over the ground.
If the F4 chatters while held still, or held up in the air, it may be much quieter when sweeping over the ground.
3. Operate in AUTOTUNE mode
Interference is much more tolerable in this mode, even at high sensitivity.

SEVERE GROUND CONDITIONS

A secondary use for the Sensitivity Control is to reduce false detection signals caused by severe ground conditions. While the detector contains circuitry to eliminate the signals caused by most naturally occurring ground minerals, 100% of all ground conditions cannot be anticipated. Highly magnetic soils found in mountainous and gold-prospecting locations can cause the detector to emit tones when metal objects are not present. High saline content soils and sands can sometimes cause the detector to beep when no metal target is present.

If the detector emits false, non-repeatable, signals, **REDUCE THE SENSITIVITY**.

QUICK-START DEMONSTRATION *(continued)*

- VI. Wave the Nail over the Search Coil
- a. The Nail will not be detected.
 - b. The Nail has been "Discriminated Out."

- VII. Press the "DISCRIMINATION +" touch pad 3 times. Five "R"s are now displayed.

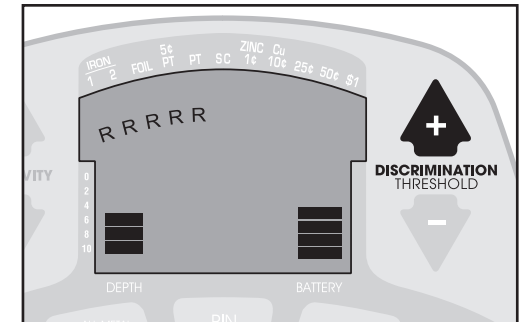

- VIII. Wave all objects over the Search Coil
The Nail and Pull-Tab will not be detected. The other objects will be detected with their own distinctive tones.

- IX. Press the NOTCH touch pad.
A flashing "▲" will appear under the IRON-1 segment.

- X. Press the DISCRIMINATION + touch pad 3 times.
The flashing "▲" will move to the 5¢ segment.

- XI. Press the NOTCH touch pad again
The "R" will disappear under 5¢ segment.

- XII. Wave the nickel over the search coil.
The nickel is detected.

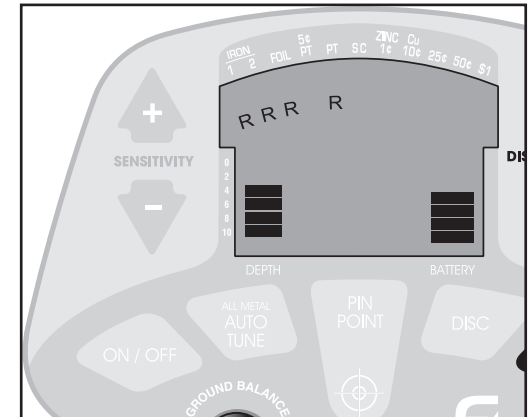

- XIII. Wave the penny over the searchcoil.
XIV. Press the NOTCH touch pad twice.
The arrow under the 1¢ segment will flash & then the "R" will illuminate.
- XV. Wave the penny over the search coil again.
The penny (the most recently detected item) is eliminated from detection.
- XVI. Press the PINPOINT touch pad.
Hold one of the metal objects motionless over the search coil.
- All Metal objects are now detected.
 - One monotone sound indicates the presence of any type of metal.
 - A 2-digit numerical display indicates approximate target depth, in inches.

CONTROL PANEL

The operating controls are as follows:

SENSITIVITY + AND -

These controls change the detector's sensitivity; higher settings enable detection of deeper targets. At power-up, the detector is pre-set to 75% of maximum sensitivity. At minimum, the sensitivity is 35% of maximum. With each press of the + or - touch pads, the sensitivity level is displayed on the bar graph on the left of the display. Upon reaching the minimum or maximum sensitivity setting, the detector will beep twice.

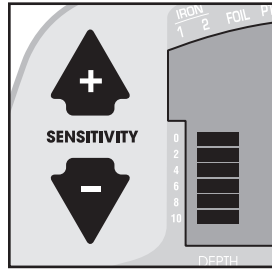

While higher levels of sensitivity enable detection of deeper targets, operation at high levels of sensitivity make the detector **more susceptible to electromagnetic interference**. Higher sensitivity settings can also lead to false signals in difficult ground conditions. Use lower sensitivity settings to suppress interference or false signals from soil minerals when necessary. **If the detector "Chatters", reduce sensitivity.**

AUTO TUNE (All Metal)

Press this pad and "ALL METAL" appears on the display

This mode is a ground-balanced All Metal motion search mode. This mode offers the maximum amount of sensitivity under most ground conditions. The search coil must be in motion to detect metal. One monotone sound is emitted. No discrimination or target identification is possible in this mode.

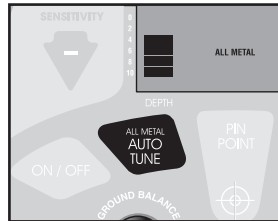

Use the **Sensitivity** or **Threshold** controls to change the sensitivity or background hum. Maximum sensitivity to buried metal objects is achieved with a slightly audible background hum.

To achieve an audible background hum:

1. Press AUTO TUNE pad to enter this mode.
2. Press **Sensitivity +** or **-** pads until you reach a desired setting. This sensitivity setting may be the highest "quiet" setting, or you may hear a faint background hum.
3. Press **Threshold +** or **-** pad until you reach a comfortable volume level.

The Sensitivity control works like a course adjustment in this mode. The Threshold control works like a fine adjustment in this mode.

The AUTO TUNE mode **must be ground-balanced** to eliminate interfering signals from soil minerals. See the section on ground balancing for a description of this procedure.

DD COIL CHARACTERISTICS

A DD coil is superior to a concentric coil, but sometimes requires a different sweep technique.

Advantages are

1. Better target separation
2. Superior performance in highly mineralized ground
3. Broader Sweep- cover more ground with each sweep

If you experience multiple responses on a shallow target, you can raise the coil, or narrow the sweep over known targets to only intersect the center section of the coil.

BOTTLE CAPS

The disadvantage of the DD coil is its propensity to classify steel bottle caps as coins.

If you hear a high tone in DISC mode and believe that it is a coin, make sure it is not a bottle cap using the following method.

1. If a repeatable ID# around 68 to 72, then it should be a dime or copper penny.
2. If not in the range of 68 to 72, then:
 - a. Sweep the back end of search coil over the target. If tone changes from high to a low tone, it is probably a bottle cap.
 - b. Sweep search coil fast across target.
 1. If tone and ID-value drop, it is probably a bottle cap.
 2. If a bottle cap, the faster you sweep, the lower the tone.

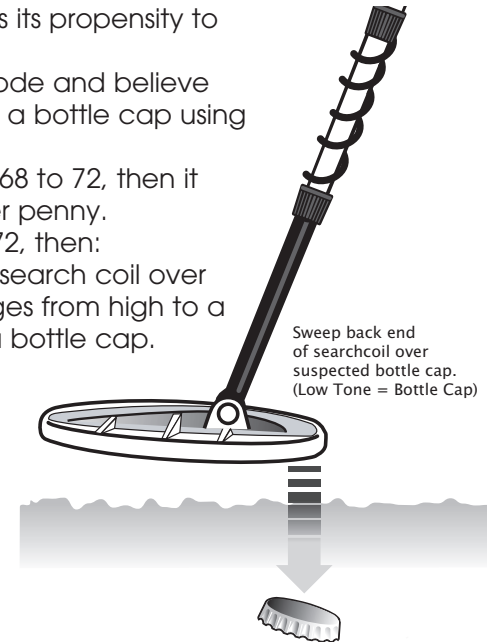

SWEET SPOT

The "center" of the DD-Coil is elongated (elliptical) from top to bottom of the coil. With some practice you will find where the center of this ellipse lies on your coil. Use this center point as a reference in pinpointing.

DEPTH AND TARGET DISPLAY

Cu/10¢: Dimes and pre-1982 pennies will register here. Older, pre-1982, pennies are composed of copper, which has a metallic signature similar to a dime. Most copper coins will register here.

Caution: The target indications are visual references. Many other types of metal can fall under any one of these categories. While the F4 will eliminate or indicate the presence of most common trash items, it is impossible to accurately classify ALL buried objects.

DEPTH INDICATOR:

The Depth Indicator is accurate for coin-sized objects. It indicates the depth of the target, in inches. Large and irregularly-shaped objects will yield less reliable depth readings

While holding the PinPoint touch pad, and passing over a metal object "depth" will appear next to the one-digit or two-digit number in the middle of the screen.

TWO DIGIT TARGET INDICATOR

The Two-digit target indicator, in the middle of the LCD display, provides a

specific target value to help identify buried targets more accurately. With practice in the field, you will learn to associate target values with the probable identification of buried objects. The target value can vary each time the coil passes over the target, depending upon the angle of the object and the distance from the coil.

As a starting point, refer to the table below.

TARGET Readout	
The table below lists some common approximate target value equivalents. With experience in the field, you will recognize many types of metals by their numeric value.	
TYPICAL VALUE	POSSIBLE OBJECTS
0-15	Iron
25-28	Pull-Tab Tail (broken off)
28-32	Nickel
36-42	Pull-Tab (old type)
58-62	Zinc, Penny
68-72	Dime & Wheat Cent
78-83	Quarter
86-90	Half Dollar
91-95	Silver Dollar

CONTROL PANEL (continued)

DISCRIMINATION (THRESHOLD) + AND -

The **function of this control depends upon the operating mode** you are in before you press these touch pads.

AUTO TUNE

+ and - will change the threshold sensitivity of the detector in this mode. This **Threshold** control operates like a fine adjustment for setting the sensitivity level and the volume of the background audible hum. If you continue to press +, you will cause the detector to make a sound, or hum, when no metal is present. Depending upon skill level and environment, some users prefer to operate in AUTO TUNE with an audible hum active at all times. At such a high "threshold," faint signals from deeply buried or very small objects will be more apparent to the user.



PINPOINT

Not applicable.

The **+ and -** touch pads have no function in this mode.

DISC

+ and - will increase or decrease the level of discrimination. Each press of the pads will cause an "R" to appear or disappear on the display. When the "R" appears, the corresponding target category will be eliminated from detection. No audible tone nor target-arrow will appear when the searchcoil passes by an object in a category with an "R" illuminated. A maximum of seven "R"s can be displayed, eliminating objects up to the Zinc-1¢ category. The four right-most target categories cannot be eliminated from detection.

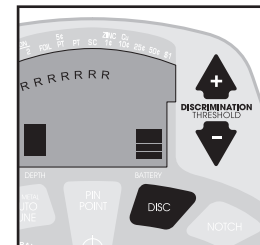

NOTCH

When Notching-Out a target, the **+ and -** pads will move a flashing arrow to the target category selected for notching. This feature allows you to discriminate items selectively across the target spectrum. While the "discrimination" control eliminates all targets from left to right, this control allows you to either add back categories previously eliminated (changing from "R" to "blank") or to selectively eliminate categories (changing from "blank" to "R").

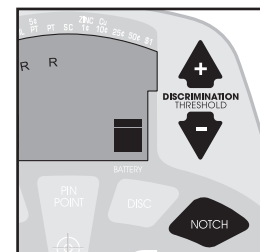

CONTROL PANEL *(continued)*

PINPOINT

This is a static search and static pinpointing mode; no coil motion over the target is required to detect metal. This mode is most effective in pinpointing the exact location of small buried objects. The detection sensitivity of this mode is controlled by the **SENSITIVITY + or -** touch pads. **Discrimination (threshold) + / -** has no function. Reduced sensitivity, and thus a smaller search field, can also be achieved by pressing the **PINPOINT** pad while an object is in the coil's detection field. The greatest sensitivity to large, deeply-buried objects is achieved with this mode. **If you plan to use PINPOINT as a continuous search mode, the detector must be ground-balanced before searching.**

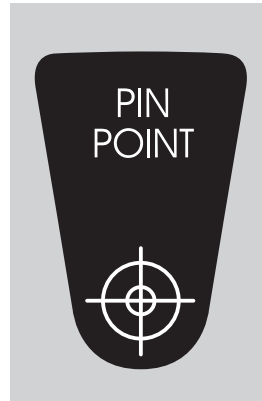

DISC

This control invokes *motion target identification* search modes.

Successive presses of the DISC pad will toggle back and forth between the:

1. All Metal Discrimination mode: a motion mode where all metal targets are detected and the:
2. Discrimination mode: a motion mode where the user can selectively eliminate target categories from detection.

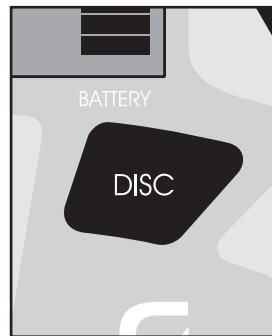

When the detector powers up, it automatically enters ALL METAL DISCRIMINATION mode with no targets eliminated from detection.

Press DISC to enter discrimination mode.

In order to **eliminate more targets** from detection, press the **DISCRIMINATION +** pad.

To reverse this target elimination, press the **DISCRIMINATION -** pad; illuminated "R"s will disappear.

DEPTH AND TARGET DISPLAY

READING THE DISPLAY

The Liquid Crystal Display (LCD) shows the PROBABLE identification of the targeted metal, as well as the PROBABLE depth of the target, in inches.

An arrow will illuminate under the target category where an object is best classified, and stay illuminated until another target is identified.

The detector will normally register a repeating, unchanging target identification when a buried target has been located and identified. If, upon repeated passes over the same spot, the target identification reads inconsistently, the target is probably a trash item, oxidized metal, or too deep to be classified accurately. With practice, you will learn to unearth only the more repeatable signals.

The segment identifications are highly accurate, when detecting the objects described on the label. However, if you register in a given category for an unknown buried object, you could be detecting a metallic object other than the object described on the label, but with the same metallic signature. Also, the greater the distance between the target and the coil, the less accurate the target identification.

GOLD TARGETS Gold objects will register on the left side of the LCD scale. Gold will register depending upon its size. The smaller the gold object, the further to the left it will register.

Gold flakes will register under Iron-1
Small gold items will register under

Iron or 5¢/PT.

Medium-sized gold items will register under PT or S-cap.

Large gold items will register under S-cap or Zinc.

SILVER TARGETS: Silver objects will normally register to the right of the scale, under 10¢, 25¢, 50¢, or \$1, depending on the size of the object. The larger the object, the farther to the right it will register.

IRON: Ferrous objects will register on the far-left side of the target identification scale. 1, or 2 indicates the relative size of iron objects. Small nails, for instance, will usually illuminate the Iron-1 arrow whereas large structural ferrous objects will usually illuminate the Iron-2 arrow.

Objects in this category could be worthless scrap, or a more valuable iron relic.

5¢/PT: Nickels and most newer pull-tabs (those that stay attached to the can) will register here.

PT (pull-tabs): Pull-tabs from older beverage cans will register here. Few newer pull-tabs will also register here. Many gold rings will also register here.

SC (Screw Caps): Screw caps from glass bottles will register here. Large gold rings, like a class ring, could also register here. Some non-U.S. coins will also register here.

ZINC/1¢: Newer pennies (post-1982) will register here. Many non-U.S. coins of recent vintage will also register here.

4-TONE AUDIO SYSTEM

While the LCD (Liquid Crystal Display) is very accurate in identifying buried objects, the user in the field does not always maintain the display screen in his field of vision. Therefore, we have incorporated an audio feedback mechanism to alert the user to the nature of buried objects. This audio feedback system first alerts the user to the presence and classification of objects, whose nature and location can be confirmed using the LCD display.

The 4-tone audio target identification system functions only in the motion modes of operation. The detector must be in the DISCRIMINATION mode, as indicated on the display. In PINPOINT or AUTOTUNE modes, the detector will emit only a monotone sound.

The detector can sound four different tones, depending on the object detected.

LOW TONE

Ferrous objects, such as iron and steel, will induce a low tone. The smallest gold objects can also induce a low tone.

LOW-MID

Pull-Tabs, nickels & smaller gold

MEDIUM TONE

Newer pennies (post-1982), larger gold objects, zinc, and small brass objects, will induce medium tones. Many recent vintage non-U.S. currencies will induce medium tones.

HIGH TONE

Silver and copper coins, larger brass objects and older pennies (pre-1982), will induce high tones. Quarters, dimes and other precious coins fall into this category.

LOW TONE	LOW-MID TONE	MEDIUM TONE	HIGH TONE
			
Nails, Iron Objects, & Smallest Gold Objects	Pull Tabs, Nickels, & Smaller Gold	Zinc Pennies (Post 1982), Larger Gold Objects	Copper, Silver & Brass Copper Pennies (Pre 1982)

Audio Target Identification (ATI) classifies metals into four categories.

CONTROL PANEL (continued)

As you sweep the searchcoil over a metal object, a **numeric target identification** will appear in the center of the display. At the same time, the **bar graph** on the left of the display will indicate the target depth, in inches. See the scale printed on label to left of the bar graph. This scale is calibrated to coin-sized objects. If the target is larger than a coin, it can be used to approximate relative target depth.

NOTCH

This control allows you to selectively include or exclude target categories from detection. The NOTCH control can be invoked from any search mode. After selecting the categories to notch-in or notch-out, the detector will always return to the **motion discrimination mode**.

Notching functions in two ways, manual or automatic.

MANUAL NOTCH

If no target arrows are visible, pressing the NOTCH pad will display an "R" under all target categories currently eliminated and the "▲" under Iron1 will flash.

Use the **Discrimination + or -** pads to move the position of the flashing "▲". Pressing NOTCH a 2nd time will change the state of the "R" under the flashing "▲"; if the "R" was previously illuminated, it will disappear. Conversely, if the "R" was not illuminated, a 2nd press of the NOTCH pad will illuminate the "R", causing this category to be eliminated from detection.

Practice by pressing the NOTCH pad in conjunction with the **Discrimination + and -** pads; their function will quickly become obvious.

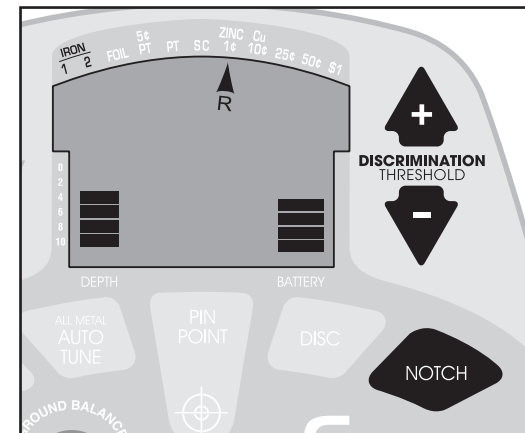

AUTOMATIC NOTCH

If a target has just been detected and a target arrow is visible, pressing NOTCH will immediately illuminate a flashing "▲" under this category. Press NOTCH a 2nd time to eliminate that target category from detection.

This Automatic Notch feature is a convenient way to quickly eliminate the most recently detected target from future detection.

GROUND BALANCING

What is Ground Balancing?

Why do I need to Ground Balance?

All soils contain minerals. Signals from ground minerals are often tens or hundreds of times as strong as the signal from a buried metal object. The magnetism of iron minerals, found in nearly all soils, causes one type of interfering signal. Dissolved mineral salts, found in some soils, are electrically conductive, causing another type of interfering signal.

Ground Balancing is the process by which the metal detector cancels the unwanted signals coming from the ground minerals while still detecting the signals from buried metal objects. This is accomplished by calibrating the detector's phase response, eliminating the signals from ground minerals.

When the detector is calibrated to the soil, the result will be deeper target detection and quieter operation.

How to Ground Balance your detector: (Preferred method)

Find a patch of ground free of metal

1. Rotate the **Ground-Balance KNOB** 100% clockwise to the **Preset** position.
2. Press the **AUTO TUNE** pad. ALL METAL appears on the display.
3. Press **Sensitivity +** pad several times to reach the highest "quiet" setting or a setting with a faint background hum.
4. Press **Threshold +** or **-** to adjust the audible hum to a comfortable level.
5. Physically **pump** the searchcoil and detector up and down over the ground. Lift the searchcoil about 6 inches above the ground and lower it to within 1 inch of the ground, about once or twice a second.
6. While pumping the searchcoil over the ground in this fashion, **slowly** rotate the KNOB counterclockwise.

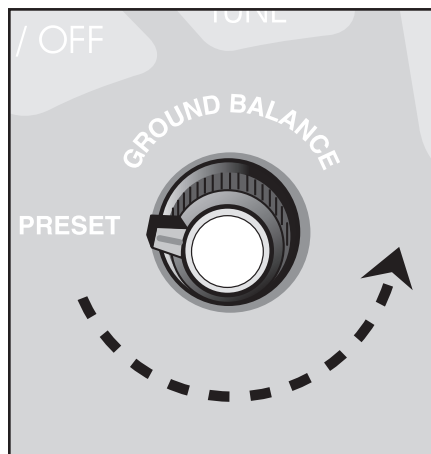

GROUND BALANCING (continued)

7. Notice that the position of the KNOB affects the sound relative to the coil's direction:
 - a. If you hear a louder sound as the searchcoil is **lowered toward the ground**, we call this **positive response**.
 - b. If you hear a louder sound as the searchcoil is **lifted away from the ground**, we call this **negative response**.
8. Rotate the knob both clockwise and counterclockwise while pumping the coil and notice the KNOB position where the sound changes from **negative response** to **positive response**.
9. Set the KNOB at the position where you achieve a **slight positive response**.
i.e. the sound is slightly louder as the coil is lowered toward the ground.

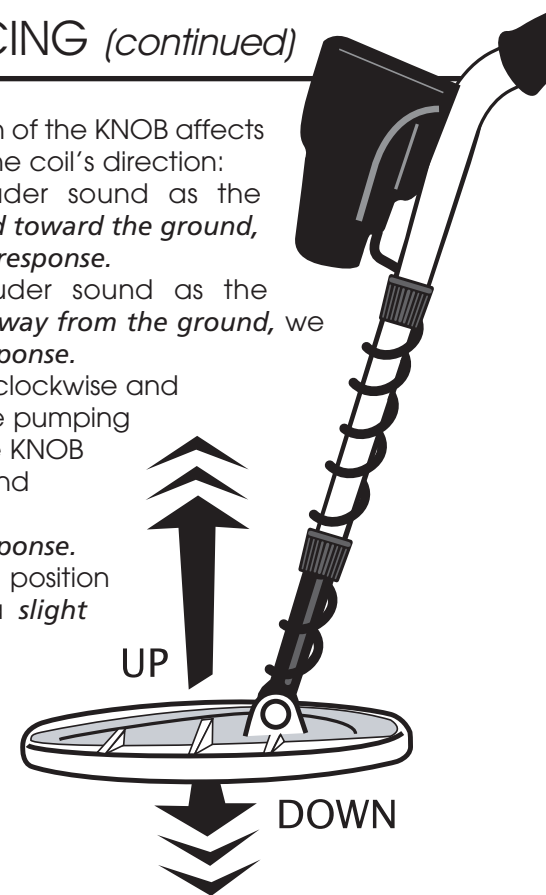

CAUTION: cannot ground balance over a metal object.

Alternate Quick Ground Balancing Method

You may also use the following, simpler method, to ground balance. While not as accurate as the coil-pumping method in AutoTune, it yields an approximate ground balance setting.

Find a patch of ground free of metal

- 1) Set the ground-balance knob at the pre-set position, 100% clockwise.
- 2) Position the searchcoil about 6" over the ground.
- 3) Press PINPOINT button
- 4) Lower searchcoil to within 1" of the ground. Sound will get louder.
- 5) Rotate knob slowly counterclockwise until detector is just silent.
- 6) Rotate knob back slightly clockwise until you hear a low volume sound. At this low-volume setting, the detector is approximately ground balanced.